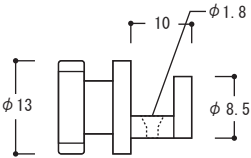
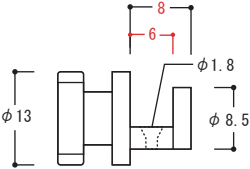
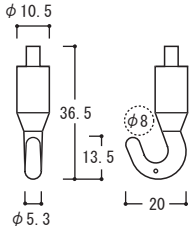
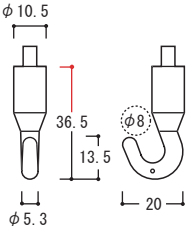
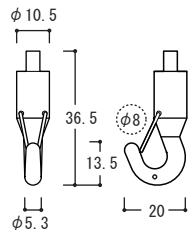
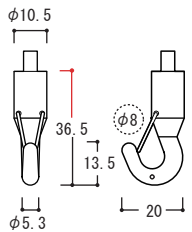
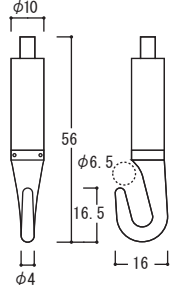
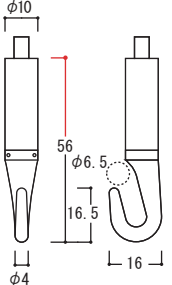
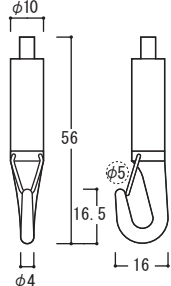
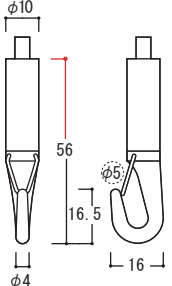
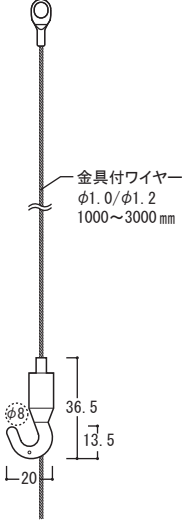
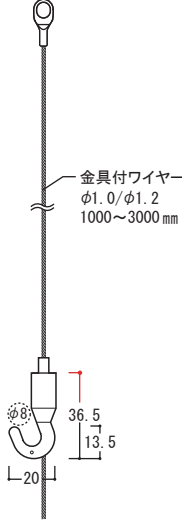
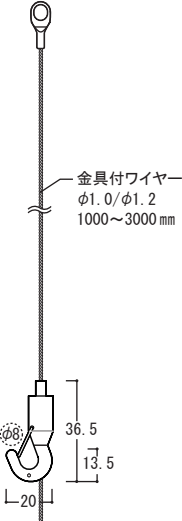
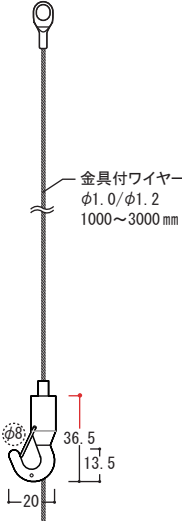
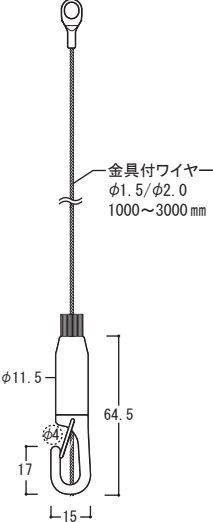
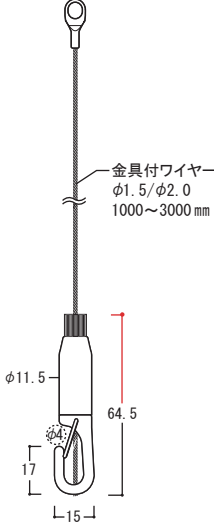

パイオニアテック 総合カタログ Vol.6 正誤表

1of11

項	訂正箇所	訂正内容	誤	正									
27	スターロック PR-CB12	寸法図誤り											
	スターロック PR-17	対応ワイヤー径訂正 耐荷重訂正	<table border="1" data-bbox="742 696 970 752"> <tr> <td>φ1.0</td> <td>φ1.2</td> <td>φ1.5</td> </tr> <tr> <td>~8kg</td> <td>~10kg</td> <td>~15kg</td> </tr> </table>	φ1.0	φ1.2	φ1.5	~8kg	~10kg	~15kg	<table border="1" data-bbox="1193 696 1342 752"> <tr> <td>φ1.2</td> <td>φ1.5</td> </tr> <tr> <td>~10kg</td> <td>~15kg</td> </tr> </table>	φ1.2	φ1.5	~10kg
φ1.0	φ1.2	φ1.5											
~8kg	~10kg	~15kg											
φ1.2	φ1.5												
~10kg	~15kg												
30	スターロック PR-24A	寸法図誤り											
31	スターロック PR-24B	寸法図誤り											
38	スターロック PR-27A	寸法図誤り											
	スターロック PR-27B	寸法図誤り											

項	訂正箇所	訂正内容	誤	正
58	スターロック AM-BWA	価格誤り	¥6,000	¥23,500
	スターロック AM-BWB	価格誤り	¥6,200	¥23,700
67	スターロック PR-MA	寸法図誤り		
	スターロック PR-MB	寸法図誤り		
69	スターロック DPR-KB	寸法図誤り		

項	訂正箇所	訂正内容	誤	正
69	スターロック DPR-KA	寸法図誤り		
76	スターロック SH-6	寸法図誤り		
81	スターロック CS-101	寸法図誤り		
87	スターロック PR-24A	寸法図誤り		
88	スターロック PR-24B	寸法図誤り		
90	スターロック PR-27A	寸法図誤り		

項	訂正箇所	訂正内容	誤	正																																																																								
90	スターロック PR-27B	寸法図誤り																																																																										
122	スターロック DR-GX	取付図誤り																																																																										
123	スターロック A/AGタイプセット	寸法図誤り																																																																										
126	スターロック B-W	表誤り	<table border="1"> <thead> <tr> <th>ワイヤー径</th> <th>A</th> <th>B</th> <th>許容荷重</th> </tr> </thead> <tbody> <tr> <td>φ0.6 mm</td> <td>6.0mm</td> <td>13.5mm</td> <td>≦3kg</td> </tr> <tr> <td>φ0.8 mm</td> <td>6.0mm</td> <td>14.5mm</td> <td>≦5kg</td> </tr> <tr> <td>φ1.0 mm</td> <td>6.0mm</td> <td>14mm</td> <td>≦8kg</td> </tr> <tr> <td>φ1.2 mm</td> <td>6.5mm</td> <td>16mm</td> <td>≦10kg</td> </tr> <tr> <td>φ1.5 mm</td> <td>7.0mm</td> <td>18.5mm</td> <td>≦20kg</td> </tr> <tr> <td>φ2.0 mm</td> <td>8.0mm</td> <td>22mm</td> <td>≦40kg</td> </tr> <tr> <td>φ2.5 mm</td> <td>9.5mm</td> <td>25mm</td> <td>≦50kg</td> </tr> <tr> <td>φ3.0 mm</td> <td>13mm</td> <td>8.0mm</td> <td>≦70kg</td> </tr> </tbody> </table>	ワイヤー径	A	B	許容荷重	φ0.6 mm	6.0mm	13.5mm	≦3kg	φ0.8 mm	6.0mm	14.5mm	≦5kg	φ1.0 mm	6.0mm	14mm	≦8kg	φ1.2 mm	6.5mm	16mm	≦10kg	φ1.5 mm	7.0mm	18.5mm	≦20kg	φ2.0 mm	8.0mm	22mm	≦40kg	φ2.5 mm	9.5mm	25mm	≦50kg	φ3.0 mm	13mm	8.0mm	≦70kg	<table border="1"> <thead> <tr> <th>ワイヤー径</th> <th>A</th> <th>B</th> <th>許容荷重</th> </tr> </thead> <tbody> <tr> <td>φ0.6 mm</td> <td>6.0mm</td> <td>13.5mm</td> <td>≦3kg</td> </tr> <tr> <td>φ0.8 mm</td> <td>6.0mm</td> <td>14.5mm</td> <td>≦5kg</td> </tr> <tr> <td>φ1.0 mm</td> <td>6.0mm</td> <td>14mm</td> <td>≦8kg</td> </tr> <tr> <td>φ1.2 mm</td> <td>6.5mm</td> <td>16mm</td> <td>≦10kg</td> </tr> <tr> <td>φ1.5 mm</td> <td>7.0mm</td> <td>18.5mm</td> <td>≦20kg</td> </tr> <tr> <td>φ2.0 mm</td> <td>8.0mm</td> <td>22mm</td> <td>≦40kg</td> </tr> <tr> <td>φ2.5 mm</td> <td>9.5mm</td> <td>25mm</td> <td>≦50kg</td> </tr> <tr> <td>φ3.0 mm</td> <td>13mm</td> <td>35mm</td> <td>≦70kg</td> </tr> </tbody> </table>	ワイヤー径	A	B	許容荷重	φ0.6 mm	6.0mm	13.5mm	≦3kg	φ0.8 mm	6.0mm	14.5mm	≦5kg	φ1.0 mm	6.0mm	14mm	≦8kg	φ1.2 mm	6.5mm	16mm	≦10kg	φ1.5 mm	7.0mm	18.5mm	≦20kg	φ2.0 mm	8.0mm	22mm	≦40kg	φ2.5 mm	9.5mm	25mm	≦50kg	φ3.0 mm	13mm	35mm	≦70kg
ワイヤー径	A	B	許容荷重																																																																									
φ0.6 mm	6.0mm	13.5mm	≦3kg																																																																									
φ0.8 mm	6.0mm	14.5mm	≦5kg																																																																									
φ1.0 mm	6.0mm	14mm	≦8kg																																																																									
φ1.2 mm	6.5mm	16mm	≦10kg																																																																									
φ1.5 mm	7.0mm	18.5mm	≦20kg																																																																									
φ2.0 mm	8.0mm	22mm	≦40kg																																																																									
φ2.5 mm	9.5mm	25mm	≦50kg																																																																									
φ3.0 mm	13mm	8.0mm	≦70kg																																																																									
ワイヤー径	A	B	許容荷重																																																																									
φ0.6 mm	6.0mm	13.5mm	≦3kg																																																																									
φ0.8 mm	6.0mm	14.5mm	≦5kg																																																																									
φ1.0 mm	6.0mm	14mm	≦8kg																																																																									
φ1.2 mm	6.5mm	16mm	≦10kg																																																																									
φ1.5 mm	7.0mm	18.5mm	≦20kg																																																																									
φ2.0 mm	8.0mm	22mm	≦40kg																																																																									
φ2.5 mm	9.5mm	25mm	≦50kg																																																																									
φ3.0 mm	13mm	35mm	≦70kg																																																																									
127	スターロック B-W	表誤り	<table border="1"> <thead> <tr> <th>ワイヤー径</th> <th>A</th> <th>B</th> <th>C</th> <th>許容荷重</th> </tr> </thead> <tbody> <tr> <td>φ1.5 mm</td> <td>111mm</td> <td>90mm</td> <td>M6 P1.0mm</td> <td>≦20kg</td> </tr> <tr> <td>φ2.0 mm</td> <td>111mm</td> <td>90mm</td> <td>M6 P1.0mm</td> <td>≦25kg</td> </tr> <tr> <td>φ2.5 mm</td> <td>121mm</td> <td>90mm</td> <td>M6 P1.25mm</td> <td>≦30kg</td> </tr> </tbody> </table>	ワイヤー径	A	B	C	許容荷重	φ1.5 mm	111mm	90mm	M6 P1.0mm	≦20kg	φ2.0 mm	111mm	90mm	M6 P1.0mm	≦25kg	φ2.5 mm	121mm	90mm	M6 P1.25mm	≦30kg	<table border="1"> <thead> <tr> <th>ワイヤー径</th> <th>A</th> <th>B</th> <th>C</th> <th>許容荷重</th> </tr> </thead> <tbody> <tr> <td>φ1.5 mm</td> <td>111mm</td> <td>90mm</td> <td>M6 P1.0mm</td> <td>≦20kg</td> </tr> <tr> <td>φ2.0 mm</td> <td>111mm</td> <td>90mm</td> <td>M6 P1.0mm</td> <td>≦25kg</td> </tr> <tr> <td>φ2.5 mm</td> <td>121mm</td> <td>90mm</td> <td>M6 P1.25mm</td> <td>≦40kg</td> </tr> </tbody> </table>	ワイヤー径	A	B	C	許容荷重	φ1.5 mm	111mm	90mm	M6 P1.0mm	≦20kg	φ2.0 mm	111mm	90mm	M6 P1.0mm	≦25kg	φ2.5 mm	121mm	90mm	M6 P1.25mm	≦40kg																																
ワイヤー径	A	B	C	許容荷重																																																																								
φ1.5 mm	111mm	90mm	M6 P1.0mm	≦20kg																																																																								
φ2.0 mm	111mm	90mm	M6 P1.0mm	≦25kg																																																																								
φ2.5 mm	121mm	90mm	M6 P1.25mm	≦30kg																																																																								
ワイヤー径	A	B	C	許容荷重																																																																								
φ1.5 mm	111mm	90mm	M6 P1.0mm	≦20kg																																																																								
φ2.0 mm	111mm	90mm	M6 P1.0mm	≦25kg																																																																								
φ2.5 mm	121mm	90mm	M6 P1.25mm	≦40kg																																																																								
130	スターロック H-18	梱包数訂正	20	—																																																																								

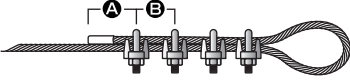
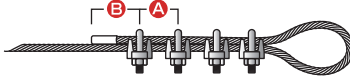
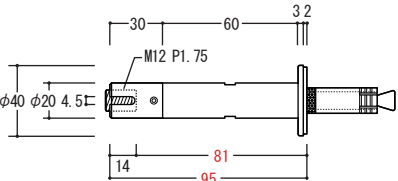
項	訂正箇所	訂正内容	誤	正																																								
130	スターロック WCP	図誤り																																										
131	スターロック H-25	取付図誤り																																										
132	スターロック PR-GC	誤表記	※1袋10入。端数販売は行っておりません。	—																																								
133	スターロック アンカー	梱包数訂正	10	—																																								
137	スターロック RS-GPM	誤表記	グリップル・プラスラージ(ワイヤー拘束金具)	グリップル・プラス <b>ミディアム</b> (ワイヤー拘束金具)																																								
161	ワイヤーオールズ WA-ATH	表誤り	<table border="1"> <thead> <tr> <th>品番</th> <th>ワイヤー径</th> <th>A</th> <th>B</th> <th>C</th> </tr> </thead> <tbody> <tr> <td>WA-ATHS</td> <td>φ2.5/φ3</td> <td>φ21</td> <td>52</td> <td>13.5</td> </tr> <tr> <td>WA-ATHM</td> <td>φ3/φ4</td> <td>φ18</td> <td>67</td> <td>14</td> </tr> <tr> <td>WA-ATHL</td> <td>φ5/φ6</td> <td>φ23</td> <td>77</td> <td>15</td> </tr> </tbody> </table>	品番	ワイヤー径	A	B	C	WA-ATHS	φ2.5/φ3	φ21	52	13.5	WA-ATHM	φ3/φ4	φ18	67	14	WA-ATHL	φ5/φ6	φ23	77	15	<table border="1"> <thead> <tr> <th>品番</th> <th>ワイヤー径</th> <th>A</th> <th>B</th> <th>C</th> </tr> </thead> <tbody> <tr> <td>WA-ATHS</td> <td>φ2.5/φ3</td> <td>φ21</td> <td>52</td> <td>13.5</td> </tr> <tr> <td>WA-ATHM</td> <td>φ3/φ4</td> <td>φ18</td> <td><b>62</b></td> <td>14</td> </tr> <tr> <td>WA-ATHL</td> <td>φ5/φ6</td> <td>φ23</td> <td>77</td> <td>15</td> </tr> </tbody> </table>	品番	ワイヤー径	A	B	C	WA-ATHS	φ2.5/φ3	φ21	52	13.5	WA-ATHM	φ3/φ4	φ18	<b>62</b>	14	WA-ATHL	φ5/φ6	φ23	77	15
品番	ワイヤー径	A	B	C																																								
WA-ATHS	φ2.5/φ3	φ21	52	13.5																																								
WA-ATHM	φ3/φ4	φ18	67	14																																								
WA-ATHL	φ5/φ6	φ23	77	15																																								
品番	ワイヤー径	A	B	C																																								
WA-ATHS	φ2.5/φ3	φ21	52	13.5																																								
WA-ATHM	φ3/φ4	φ18	<b>62</b>	14																																								
WA-ATHL	φ5/φ6	φ23	77	15																																								
162	ワイヤーオールズ WA-ATF	表誤り	<table border="1"> <thead> <tr> <th>品番</th> <th>ワイヤー径</th> <th>A</th> <th>B</th> <th>C</th> </tr> </thead> <tbody> <tr> <td>WA-ATFS</td> <td>φ2.5/φ3</td> <td>φ21</td> <td>88.5</td> <td>18</td> </tr> <tr> <td>WA-ATFM</td> <td>φ3/φ4</td> <td>φ18</td> <td>96.5</td> <td>17.5</td> </tr> <tr> <td>WA-ATFL</td> <td>φ5/φ6</td> <td>φ23</td> <td>117.5</td> <td>20</td> </tr> </tbody> </table>	品番	ワイヤー径	A	B	C	WA-ATFS	φ2.5/φ3	φ21	88.5	18	WA-ATFM	φ3/φ4	φ18	96.5	17.5	WA-ATFL	φ5/φ6	φ23	117.5	20	<table border="1"> <thead> <tr> <th>品番</th> <th>ワイヤー径</th> <th>A</th> <th>B</th> <th>C</th> </tr> </thead> <tbody> <tr> <td>WA-ATFS</td> <td>φ2.5/φ3</td> <td>φ21</td> <td>88.5</td> <td>18</td> </tr> <tr> <td>WA-ATFM</td> <td>φ3/φ4</td> <td>φ18</td> <td><b>91.5</b></td> <td>17.5</td> </tr> <tr> <td>WA-ATFL</td> <td>φ5/φ6</td> <td>φ23</td> <td>117.5</td> <td>20</td> </tr> </tbody> </table>	品番	ワイヤー径	A	B	C	WA-ATFS	φ2.5/φ3	φ21	88.5	18	WA-ATFM	φ3/φ4	φ18	<b>91.5</b>	17.5	WA-ATFL	φ5/φ6	φ23	117.5	20
品番	ワイヤー径	A	B	C																																								
WA-ATFS	φ2.5/φ3	φ21	88.5	18																																								
WA-ATFM	φ3/φ4	φ18	96.5	17.5																																								
WA-ATFL	φ5/φ6	φ23	117.5	20																																								
品番	ワイヤー径	A	B	C																																								
WA-ATFS	φ2.5/φ3	φ21	88.5	18																																								
WA-ATFM	φ3/φ4	φ18	<b>91.5</b>	17.5																																								
WA-ATFL	φ5/φ6	φ23	117.5	20																																								
183	ワイヤーオールズ WA-PA35H	寸法図誤り																																										
188	ワイヤーオールズ WA-GS	寸法図誤り																																										

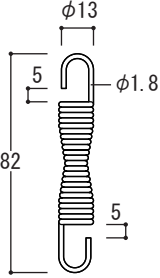
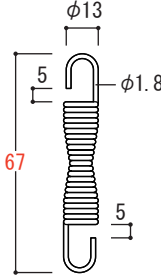
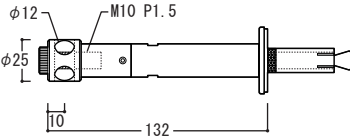
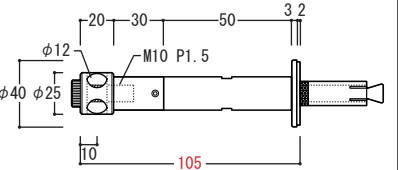
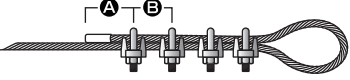
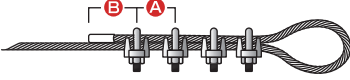
項	訂正箇所	訂正内容	誤	正																																				
189	ワイヤーオールズ WA-GS	誤表記	フックバネW	フックバネD																																				
		寸法図誤り																																						
191	ワイヤーオールズ WA-PA36H	寸法図誤り																																						
194	ワイヤーオールズ BP-2	注釈記載漏れ	/	・座金の向きが変えられます。																																				
	ワイヤーオールズ BP-3	注釈記載漏れ		・座金の向きが変えられます。																																				
195	ワイヤーオールズ EZワイヤー	ワイヤー径訂正	φ3.0	φ2.5																																				
196	ワイヤーオールズ リングワイヤー	梱包数訂正	20	—																																				
198	ワイヤーオールズ WCP	図誤り																																						
198	ワイヤーオールズ H-17	表誤り	<table border="1"> <thead> <tr> <th>対応ワイヤー径</th> <th>A</th> <th>B</th> <th>C</th> <th>D</th> <th>E</th> </tr> </thead> <tbody> <tr> <td>φ0.6/φ0.8</td> <td>5</td> <td>2.5</td> <td>3.2</td> <td>1.8</td> <td>1.0</td> </tr> <tr> <td>φ2.5 mm</td> <td>8</td> <td>5.5</td> <td>8.5</td> <td>6.2</td> <td>3.2</td> </tr> </tbody> </table>	対応ワイヤー径	A	B	C	D	E	φ0.6/φ0.8	5	2.5	3.2	1.8	1.0	φ2.5 mm	8	5.5	8.5	6.2	3.2	<table border="1"> <thead> <tr> <th>対応ワイヤー径</th> <th>A</th> <th>B</th> <th>C</th> <th>D</th> <th>E</th> </tr> </thead> <tbody> <tr> <td>φ0.6/φ0.8</td> <td>5</td> <td>2.5</td> <td>3.2</td> <td>1.8</td> <td>1.0</td> </tr> <tr> <td>φ2.5 mm</td> <td>9</td> <td>5</td> <td>7.7</td> <td>5.3</td> <td>2.8</td> </tr> </tbody> </table>	対応ワイヤー径	A	B	C	D	E	φ0.6/φ0.8	5	2.5	3.2	1.8	1.0	φ2.5 mm	9	5	7.7	5.3	2.8
			対応ワイヤー径	A	B	C	D	E																																
φ0.6/φ0.8	5	2.5	3.2	1.8	1.0																																			
φ2.5 mm	8	5.5	8.5	6.2	3.2																																			
対応ワイヤー径	A	B	C	D	E																																			
φ0.6/φ0.8	5	2.5	3.2	1.8	1.0																																			
φ2.5 mm	9	5	7.7	5.3	2.8																																			
<table border="1"> <thead> <tr> <th>コード</th> <th>品番</th> <th>対応ワイヤー径</th> <th>梱包数</th> <th>価格</th> </tr> </thead> <tbody> <tr> <td>310125</td> <td>H-17E</td> <td>φ0.6/φ0.8</td> <td>—</td> <td>¥350</td> </tr> <tr> <td>310124</td> <td>H-17D</td> <td>φ2.5</td> <td>—</td> <td>¥700</td> </tr> </tbody> </table>			コード	品番	対応ワイヤー径	梱包数	価格	310125	H-17E	φ0.6/φ0.8	—	¥350	310124	H-17D	φ2.5	—	¥700	<table border="1"> <thead> <tr> <th>コード</th> <th>品番</th> <th>対応ワイヤー径</th> <th>梱包数</th> <th>価格</th> </tr> </thead> <tbody> <tr> <td>310125</td> <td>H-17E</td> <td>φ0.6/φ0.8</td> <td>—</td> <td>¥350</td> </tr> <tr> <td>310123</td> <td>H-17C</td> <td>φ2.0/φ2.5</td> <td>—</td> <td>¥500</td> </tr> </tbody> </table>			コード	品番	対応ワイヤー径	梱包数	価格	310125	H-17E	φ0.6/φ0.8	—	¥350	310123	H-17C	φ2.0/φ2.5	—	¥500					
コード	品番	対応ワイヤー径	梱包数	価格																																				
310125	H-17E	φ0.6/φ0.8	—	¥350																																				
310124	H-17D	φ2.5	—	¥700																																				
コード	品番	対応ワイヤー径	梱包数	価格																																				
310125	H-17E	φ0.6/φ0.8	—	¥350																																				
310123	H-17C	φ2.0/φ2.5	—	¥500																																				

項	訂正箇所	訂正内容	誤	正
199	ワイヤーオールズ RS-GPM	誤表記	グリップル・プラスラージ(ワイヤー拘束金具)	グリップル・プラス <b>ミディアム</b> (ワイヤー拘束金具)
200	ワイヤーオールズ WA-PA47S	寸法図不足		<p>17.8 9</p> <p>WA-AZH WA-AZF</p>
255	pt-pop PT-R	取付図誤り	<p>ゴムパッキン×2 ゴムパッキン</p> <p>6mmガラスの場合 8mmガラスの場合</p> <p>ガラス(6mm) ガラス(8mm)</p> <p>ガラスパッキン×2 ガラスパッキン×1</p>	<p>ゴムパッキン×2</p> <p>6mmガラスの場合</p> <p>ガラス(6mm) ゴムパッキン×2</p>
257	pt-pop PT-MGA	寸法図誤り	<p>M6 P1.0</p> <p>20 1 6.5 20 20 5</p>	<p>M6 P1.0</p> <p>20 1 6.5 20 15 5</p>
258	pt-pop PT-SB	寸法図誤り	<p>M3 六角穴付ネジ(六角レンチ1.5)</p> <p>M10 P1.5</p> <p>13 4.2 11 10/15/20 11 4.5 4.2 5 4x20 13 8</p>	<p>M3 六角穴付ネジ(六角レンチ1.5)</p> <p>M10 P1.5</p> <p>13 4.2 11 10/15/20 11 4.5 4.2 5 4x35 4x40 4x45 13 8</p>

項	訂正箇所	訂正内容	誤	正																																																																																																				
258	pt-pop PT-SB	表誤り	<table border="1"> <thead> <tr> <th>コード</th> <th>品番</th> <th>仕上</th> <th>キャップ径</th> <th>パイプ長</th> </tr> </thead> <tbody> <tr> <td>541004</td> <td>PT-B13SE10-CR</td> <td></td> <td></td> <td>13mm</td> </tr> <tr> <td>541005</td> <td>PT-B13SE10-CR</td> <td></td> <td>φ13</td> <td>15mm</td> </tr> <tr> <td>541006</td> <td>PT-B13SE10-CR</td> <td></td> <td></td> <td>20mm</td> </tr> <tr> <td>541007</td> <td>PT-B13SE10-CR</td> <td></td> <td></td> <td>13mm</td> </tr> <tr> <td>541008</td> <td>PT-B13SE10-CR</td> <td>クローム</td> <td>φ15</td> <td>15mm</td> </tr> <tr> <td>541009</td> <td>PT-B13SE10-CR</td> <td></td> <td></td> <td>20mm</td> </tr> <tr> <td>541010</td> <td>PT-B13SE10-CR</td> <td></td> <td></td> <td>13mm</td> </tr> <tr> <td>541011</td> <td>PT-B13SE10-CR</td> <td></td> <td>φ20</td> <td>15mm</td> </tr> <tr> <td>541012</td> <td>PT-B13SE10-CR</td> <td></td> <td></td> <td>20mm</td> </tr> </tbody> </table>	コード	品番	仕上	キャップ径	パイプ長	541004	PT-B13SE10-CR			13mm	541005	PT-B13SE10-CR		φ13	15mm	541006	PT-B13SE10-CR			20mm	541007	PT-B13SE10-CR			13mm	541008	PT-B13SE10-CR	クローム	φ15	15mm	541009	PT-B13SE10-CR			20mm	541010	PT-B13SE10-CR			13mm	541011	PT-B13SE10-CR		φ20	15mm	541012	PT-B13SE10-CR			20mm	<table border="1"> <thead> <tr> <th>コード</th> <th>品番</th> <th>仕上</th> <th>キャップ径</th> <th>パイプ長</th> </tr> </thead> <tbody> <tr> <td>541004</td> <td>PT-B13SE10-CR</td> <td></td> <td></td> <td>10mm</td> </tr> <tr> <td>541005</td> <td>PT-B13SE10-CR</td> <td></td> <td>φ13</td> <td>15mm</td> </tr> <tr> <td>541006</td> <td>PT-B13SE10-CR</td> <td></td> <td></td> <td>20mm</td> </tr> <tr> <td>541007</td> <td>PT-B13SE10-CR</td> <td></td> <td></td> <td>10mm</td> </tr> <tr> <td>541008</td> <td>PT-B13SE10-CR</td> <td>クローム</td> <td>φ15</td> <td>15mm</td> </tr> <tr> <td>541009</td> <td>PT-B13SE10-CR</td> <td></td> <td></td> <td>20mm</td> </tr> <tr> <td>541010</td> <td>PT-B13SE10-CR</td> <td></td> <td></td> <td>10mm</td> </tr> <tr> <td>541011</td> <td>PT-B13SE10-CR</td> <td></td> <td>φ20</td> <td>15mm</td> </tr> <tr> <td>541012</td> <td>PT-B13SE10-CR</td> <td></td> <td></td> <td>20mm</td> </tr> </tbody> </table>	コード	品番	仕上	キャップ径	パイプ長	541004	PT-B13SE10-CR			10mm	541005	PT-B13SE10-CR		φ13	15mm	541006	PT-B13SE10-CR			20mm	541007	PT-B13SE10-CR			10mm	541008	PT-B13SE10-CR	クローム	φ15	15mm	541009	PT-B13SE10-CR			20mm	541010	PT-B13SE10-CR			10mm	541011	PT-B13SE10-CR		φ20	15mm	541012	PT-B13SE10-CR			20mm
	コード	品番	仕上	キャップ径	パイプ長																																																																																																			
541004	PT-B13SE10-CR			13mm																																																																																																				
541005	PT-B13SE10-CR		φ13	15mm																																																																																																				
541006	PT-B13SE10-CR			20mm																																																																																																				
541007	PT-B13SE10-CR			13mm																																																																																																				
541008	PT-B13SE10-CR	クローム	φ15	15mm																																																																																																				
541009	PT-B13SE10-CR			20mm																																																																																																				
541010	PT-B13SE10-CR			13mm																																																																																																				
541011	PT-B13SE10-CR		φ20	15mm																																																																																																				
541012	PT-B13SE10-CR			20mm																																																																																																				
コード	品番	仕上	キャップ径	パイプ長																																																																																																				
541004	PT-B13SE10-CR			10mm																																																																																																				
541005	PT-B13SE10-CR		φ13	15mm																																																																																																				
541006	PT-B13SE10-CR			20mm																																																																																																				
541007	PT-B13SE10-CR			10mm																																																																																																				
541008	PT-B13SE10-CR	クローム	φ15	15mm																																																																																																				
541009	PT-B13SE10-CR			20mm																																																																																																				
541010	PT-B13SE10-CR			10mm																																																																																																				
541011	PT-B13SE10-CR		φ20	15mm																																																																																																				
541012	PT-B13SE10-CR			20mm																																																																																																				
	pt-pop PT-SC	表誤り	<table border="1"> <thead> <tr> <th>コード</th> <th>品番</th> <th>仕上</th> <th>キャップ径</th> </tr> </thead> <tbody> <tr> <td>541013</td> <td>PT-C13SE8-CR</td> <td></td> <td>13mm</td> </tr> <tr> <td>541014</td> <td>PT-C15SE8-CR</td> <td>クローム</td> <td>15mm</td> </tr> <tr> <td>541015</td> <td>PT-C20SE8-CR</td> <td></td> <td>20mm</td> </tr> <tr> <td>541016</td> <td>PT-C25SE8-CR</td> <td></td> <td>25mm</td> </tr> </tbody> </table>	コード	品番	仕上	キャップ径	541013	PT-C13SE8-CR		13mm	541014	PT-C15SE8-CR	クローム	15mm	541015	PT-C20SE8-CR		20mm	541016	PT-C25SE8-CR		25mm	<table border="1"> <thead> <tr> <th>コード</th> <th>品番</th> <th>仕上</th> <th>キャップ径</th> </tr> </thead> <tbody> <tr> <td>541013</td> <td>PT-C13SE8-CR</td> <td></td> <td>13mm</td> </tr> <tr> <td>541014</td> <td>PT-C15SE8-CR</td> <td>クローム</td> <td>15mm</td> </tr> <tr> <td>541015</td> <td>PT-C20SE10-CR</td> <td></td> <td>20mm</td> </tr> <tr> <td>541016</td> <td>PT-C25SE10-CR</td> <td></td> <td>25mm</td> </tr> </tbody> </table>	コード	品番	仕上	キャップ径	541013	PT-C13SE8-CR		13mm	541014	PT-C15SE8-CR	クローム	15mm	541015	PT-C20SE10-CR		20mm	541016	PT-C25SE10-CR		25mm																																																												
コード	品番	仕上	キャップ径																																																																																																					
541013	PT-C13SE8-CR		13mm																																																																																																					
541014	PT-C15SE8-CR	クローム	15mm																																																																																																					
541015	PT-C20SE8-CR		20mm																																																																																																					
541016	PT-C25SE8-CR		25mm																																																																																																					
コード	品番	仕上	キャップ径																																																																																																					
541013	PT-C13SE8-CR		13mm																																																																																																					
541014	PT-C15SE8-CR	クローム	15mm																																																																																																					
541015	PT-C20SE10-CR		20mm																																																																																																					
541016	PT-C25SE10-CR		25mm																																																																																																					
260	pt-pop PR-20H	誤表記	[右側・左側1セット]	—																																																																																																				
262	PT-NSF 化粧キャップNS	誤表記	各タイプ共タッピングビス⊕皿が 付属していますが 別サイズ及びステンレス製も ご用意しています。[P.293]	—																																																																																																				
271	PT-XF 化粧キャップXF	寸法図誤り																																																																																																						
271	PT-XR 化粧キャップXR	寸法図誤り																																																																																																						



項	訂正箇所	訂正内容	誤	正																																												
	PF-SF 化粧キャップSF	寸法図誤り																																														
		付属品誤り	パッキン×2	硬質パッキン×2																																												
272	PF-SP 化粧キャップSP	寸法図誤り																																														
		付属品誤り	パッキン×2	硬質パッキン×2																																												
	pt-pop 六角穴付き皿ボルト	価格誤り	<table border="1"> <thead> <tr> <th>コード</th> <th>品番</th> <th>サイズ</th> <th>梱包数</th> <th>価格</th> </tr> </thead> <tbody> <tr> <td>902402</td> <td rowspan="4">六角穴付き皿ボルト</td> <td>M5×30mm</td> <td></td> <td>¥280</td> </tr> <tr> <td>902403</td> <td>M5×50mm</td> <td></td> <td>¥480</td> </tr> <tr> <td>902226</td> <td>M6×30mm</td> <td></td> <td>¥320</td> </tr> <tr> <td>902230</td> <td>M6×50mm</td> <td></td> <td>¥620</td> </tr> </tbody> </table>	コード	品番	サイズ	梱包数	価格	902402	六角穴付き皿ボルト	M5×30mm		¥280	902403	M5×50mm		¥480	902226	M6×30mm		¥320	902230	M6×50mm		¥620	<table border="1"> <thead> <tr> <th>コード</th> <th>品番</th> <th>サイズ</th> <th>梱包数</th> <th>価格</th> </tr> </thead> <tbody> <tr> <td>902402</td> <td rowspan="4">六角穴付き皿ボルト</td> <td>M5×30mm</td> <td></td> <td>¥280</td> </tr> <tr> <td>902403</td> <td>M5×50mm</td> <td></td> <td>¥480</td> </tr> <tr> <td>902226</td> <td>M6×30mm</td> <td></td> <td>¥480</td> </tr> <tr> <td>902230</td> <td>M6×50mm</td> <td></td> <td>¥640</td> </tr> </tbody> </table>	コード	品番	サイズ	梱包数	価格	902402	六角穴付き皿ボルト	M5×30mm		¥280	902403	M5×50mm		¥480	902226	M6×30mm		¥480	902230	M6×50mm		¥640
コード	品番	サイズ	梱包数	価格																																												
902402	六角穴付き皿ボルト	M5×30mm		¥280																																												
902403		M5×50mm		¥480																																												
902226		M6×30mm		¥320																																												
902230		M6×50mm		¥620																																												
コード	品番	サイズ	梱包数	価格																																												
902402	六角穴付き皿ボルト	M5×30mm		¥280																																												
902403		M5×50mm		¥480																																												
902226		M6×30mm		¥480																																												
902230		M6×50mm		¥640																																												
322	SPP CL-SC830	寸法図誤り																																														
351	SPP MS-V03	寸法図誤り																																														

項	訂正箇所	訂正内容	誤	正																				
369	SPP CL-SC830	施工ガイド誤り 扉ガラス加工寸法図																						
381	ブースバー BC32-BC/BC45-BC	寸法図誤り																						
385	ブースバー BC32-BC/BC45-BC	寸法図誤り																						
417	ベリル BR-TH	寸法図誤り																						
447	ウォールライン WL-18	寸法図誤り																						
459	ウォールライン WD-3	品番・サイズ誤り	<table border="1"> <thead> <tr> <th>コード</th> <th>品番</th> <th>仕上</th> <th>サイズ</th> </tr> </thead> <tbody> <tr> <td>500188</td> <td>WD3-1840-SA</td> <td>シルバー</td> <td>1840mm</td> </tr> <tr> <td>500189</td> <td>WD3-3700-SA</td> <td>シルバー</td> <td>3700mm</td> </tr> </tbody> </table>	コード	品番	仕上	サイズ	500188	WD3-1840-SA	シルバー	1840mm	500189	WD3-3700-SA	シルバー	3700mm	<table border="1"> <thead> <tr> <th>コード</th> <th>品番</th> <th>仕上</th> <th>サイズ</th> </tr> </thead> <tbody> <tr> <td>500189</td> <td>WD3-3000-SA</td> <td>シルバー</td> <td>3000mm</td> </tr> </tbody> </table>	コード	品番	仕上	サイズ	500189	WD3-3000-SA	シルバー	3000mm
コード	品番	仕上	サイズ																					
500188	WD3-1840-SA	シルバー	1840mm																					
500189	WD3-3700-SA	シルバー	3700mm																					
コード	品番	仕上	サイズ																					
500189	WD3-3000-SA	シルバー	3000mm																					
460	ウォールライン WD-4	品番・サイズ誤り	<table border="1"> <thead> <tr> <th>コード</th> <th>品番</th> <th>仕上</th> <th>サイズ</th> </tr> </thead> <tbody> <tr> <td>500190</td> <td>WD4-1840-SA</td> <td>シルバー</td> <td>1840mm</td> </tr> <tr> <td>500191</td> <td>WD4-3700-SA</td> <td>シルバー</td> <td>3700mm</td> </tr> </tbody> </table>	コード	品番	仕上	サイズ	500190	WD4-1840-SA	シルバー	1840mm	500191	WD4-3700-SA	シルバー	3700mm	<table border="1"> <thead> <tr> <th>コード</th> <th>品番</th> <th>仕上</th> <th>サイズ</th> </tr> </thead> <tbody> <tr> <td>500191</td> <td>WD4-3000-SA</td> <td>シルバー</td> <td>3000mm</td> </tr> </tbody> </table>	コード	品番	仕上	サイズ	500191	WD4-3000-SA	シルバー	3000mm
コード	品番	仕上	サイズ																					
500190	WD4-1840-SA	シルバー	1840mm																					
500191	WD4-3700-SA	シルバー	3700mm																					
コード	品番	仕上	サイズ																					
500191	WD4-3000-SA	シルバー	3000mm																					
461	ウォールライン WD-F1B	寸法図誤り																						

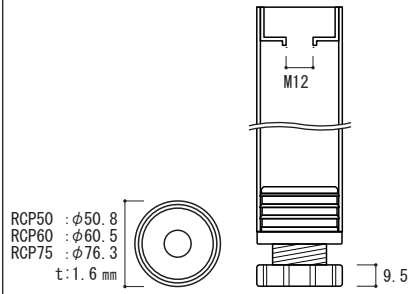
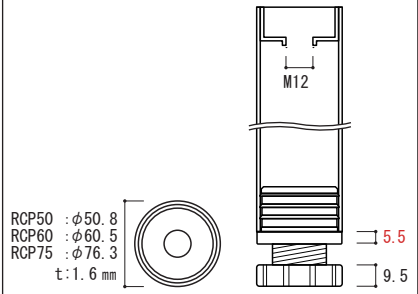
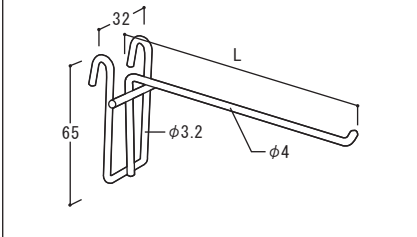
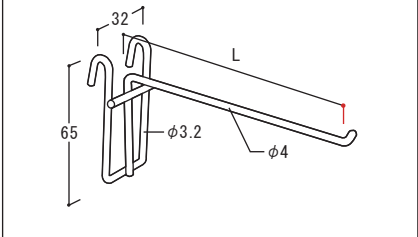
項	訂正箇所	訂正内容	誤	正
554	レミーポール RCP	寸法値不足	 <p>RCP50 : φ50.8 RCP60 : φ60.5 RCP75 : φ76.3 t:1.6 mm</p>	 <p>RCP50 : φ50.8 RCP60 : φ60.5 RCP75 : φ76.3 t:1.6 mm</p>
	レミーポール RCM	注釈記載漏れ	/	<ul style="list-style-type: none"> <li>RCM40に対応している座金はRCS-80のみです。</li> </ul>
	レミーポール RCT	注釈記載漏れ		<ul style="list-style-type: none"> <li>RCM40には対応していません。</li> </ul>
568	アクティネット KH-2C	寸法図誤り		
	アクティネット KH-2D	寸法図誤り	